

# Wood Experience

**LEA**  
CERAMICHE

# Sommario.

\_Summary.

\_Wood Experience. 4-5

\_Formati. 6-7

\_L'ispirazione di Partenza. 8-9

\_I Colori Freddi. 10-11 / 14-29

\_I Colori Caldi. 12-13 / 30-51

\_Wood Experience. 4-5

\_Sizes. 6-7

\_The inspiration. 8-9

\_The Cold Colors. 10-11 / 14-29

\_The Warm Colors. 12-13 / 30-51



La materia  
che dialoga con la natura.  
Superfici invecchiate,  
trattate e realizzate  
ad arte.

Tra vero e verosimile  
le proposte “wood look”  
di Lea Ceramiche.  
Nuove forme di espressione  
materica in una sempre  
più consapevole  
cornice green.

The material that interacts with nature.  
Aged surfaces, skillfully treated and  
converted into an art.  
Between real and verisimilitude  
“wood look” proposals by Lea Ceramiche.  
New forms of expression made in an ever  
more conscious green framework.

# Wood Experience.

---

Wood Experience è il nuovo catalogo di Lea Ceramiche dedicato alle collezioni che riproducono l'effetto legno. Una ricca panoramica con proposte in grado di rispondere a qualsiasi stile e gusto estetico, destinate agli ambiti più svariati, dal residenziale al contract, dall'interior agli spazi outdoor.

Punto di partenza è il gres porcellanato, dalle proprietà straordinarie e adatto ad interpretare materiali naturali restituiti, grazie all'avanzamento della stampa digitale, con texture sempre più verosimili. La materia prima selezionata (argille, minerali quarzosi e felspati) prende forma passando attraverso accurate e meticolose fasi produttive sempre nel massimo rispetto dell'ambiente. La stampa digitale riesce a riprodurre con stupefacente realismo non solo le cromie e la texture caratteristiche delle essenze lignee ma irregolarità, sfumature, imprecisioni.

Non una usuale "fotocopia digitale" o semplici recuperi di disegni e immagini. Qui lo scarto è dato dalle innumerevoli prove e da una paziente ricerca di perfezione perseguita dall'Azienda che rendono il gres porcellanato, oltre al prodotto più funzionale ed inalterabile nel tempo, anche il materiale più versatile e multiforme tra quelli esistenti.

Wood Experience is the new catalog of Lea Ceramiche dedicated to collections that reproduce a wood effect. A rich overview of proposals, capable of satisfying any style and aesthetics, aimed at a wide range of areas, from residential to contract, from interior to outdoor spaces.

The starting point is porcelain, a highly resistant product suitable for reproducing natural materials, which combined with the latest technology in digital printing, results in an ever-increasing realistic final texture.

The raw materials (clays, mineral quartz and feldspar) are produced with an accurate and meticulous manufacturing process that always respects the environment.

The result is not a "digital photocopy" or a simple reproduction of drawings and images. Here, the difference is made by the countless trials and the patient research for perfection pursued by the company, making porcelain stoneware, not only the most functional and durable product, but also the most versatile and manifold material amongst existing ones.

# Formati.

## \_Sizes.

La ricerca di Lea Ceramiche si muove anche sull'aspetto dimensionale. Un'ampia varietà di formati, trasposizione dei tradizionali listoni in legno, propone moduli sia rettificati che dal bordo irregolare nel classico spessore di 11mm. Lastre extrasize (fino a 33x300cm) sono invece disponibili nello spessore sottile di 5,5mm, ultima trasformazione della ceramica che con le nuove tecnologie apre a molteplici opportunità per l'architettura e per il design. Da ultimo il modulo stretto e lungo di 12x120cm con finitura deck antiscivolo, ideale per spazi esterni.

A wide variety of formats, replicating traditional wood-planks, are available not only as rectified tiles, but also with non-rectified edges, in the classic 11mm thickness. Extrasize tiles (up to 33x300cm) are available in a 5.5mm thickness; this is the latest technology in ceramics manufacturing that opens up many opportunities for architecture and design.

33x300cm 13"x118"  
slimtech 5plus



20x200cm 8"x79"  
slimtech 5plus



20x150cm 8"x59"  
slimtech 5plus



20x100cm 8"x39"  
slimtech 5plus



30x120cm  
12"x48"



20x120cm  
8"x48"



20x90,5cm  
8"x36"



12x120cm  
4 3/4"x48"



# L'ispirazione di partenza.

\_The inspiration.

La ricerca di Lea Ceramiche si è focalizzata sul legno di rovere, essenza tra le più nobili e pregiate. Un lavoro lungo e meticoloso, iniziato con la rilevazione delle tonalità originarie e proseguito con la messa a punto di ciascun colore e con la declinazione di ciascuna finitura. La tecnica produttiva prevede la combinazione di svariati disegni per ogni colore, che attraverso un'avanzata stampa digitale tracciano sul materiale ceramico venature ed anticature sempre diverse, ricreando fedelmente l'irregolarità del legno e i segni del tempo. Il risultato finale prevede cinque diverse collezioni che si contraddistinguono ciascuna per texture, formati e spessori. La materia ceramica viene restituita con finitura ora ruvida, usurata o trattata, leggere ma significative differenze visibili e percepibili al tatto per esaltare la bellezza imperfetta ma sempre autentica del legno.

The research by Lea Ceramiche, focused on oak, one of the most noble and valued wood species. A long, meticulous task that began with the analysis of the original tones and feel, the development of each color and the declination of each finish. The production technique gives way to the combination of a variety of drawings for each color, which, through advanced digital printing, outline unique antique veins on the ceramic material that faithfully reproduce the irregularity and ageing of wood.

The result is 5 different collections that are different in texture, size and thicknesses. The ceramic material is offered in a finish that is rough, worn or treated, but with significant differences that are both visible and tactile. These enhance the imperfect but always authentic beauty of wood.

1\_ Bio Timber  
3\_ Sunrise

2\_ Bio Lumber  
4\_ Wood-stock

5\_ Bio Plank

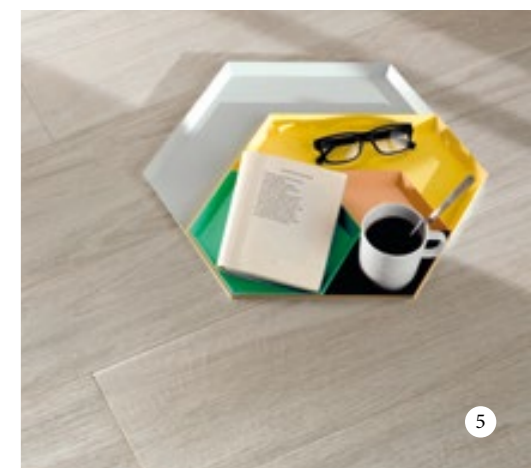
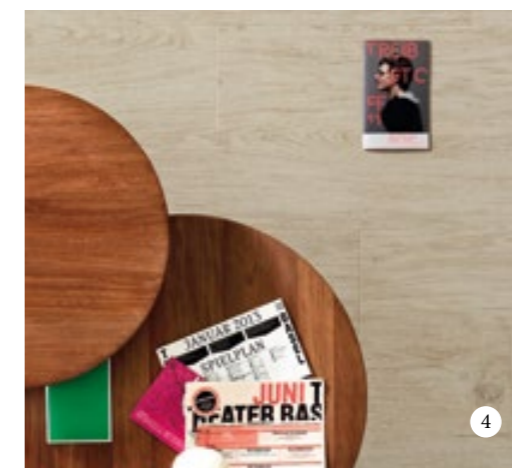

# I Colori Freddi.

\_The Cold Colors.

La base sono i grigi, i marroni, i verdi, ma all'interno di questa gamma le declinazioni di colore spaziano dalle gradazioni più chiare a quelle più scure. Le tonalità fredde lasciano più spazio all'immaginazione.

The base colors are grays, browns, greens, with varying light/dark contrasts. The colder tones leave room to the imagination.

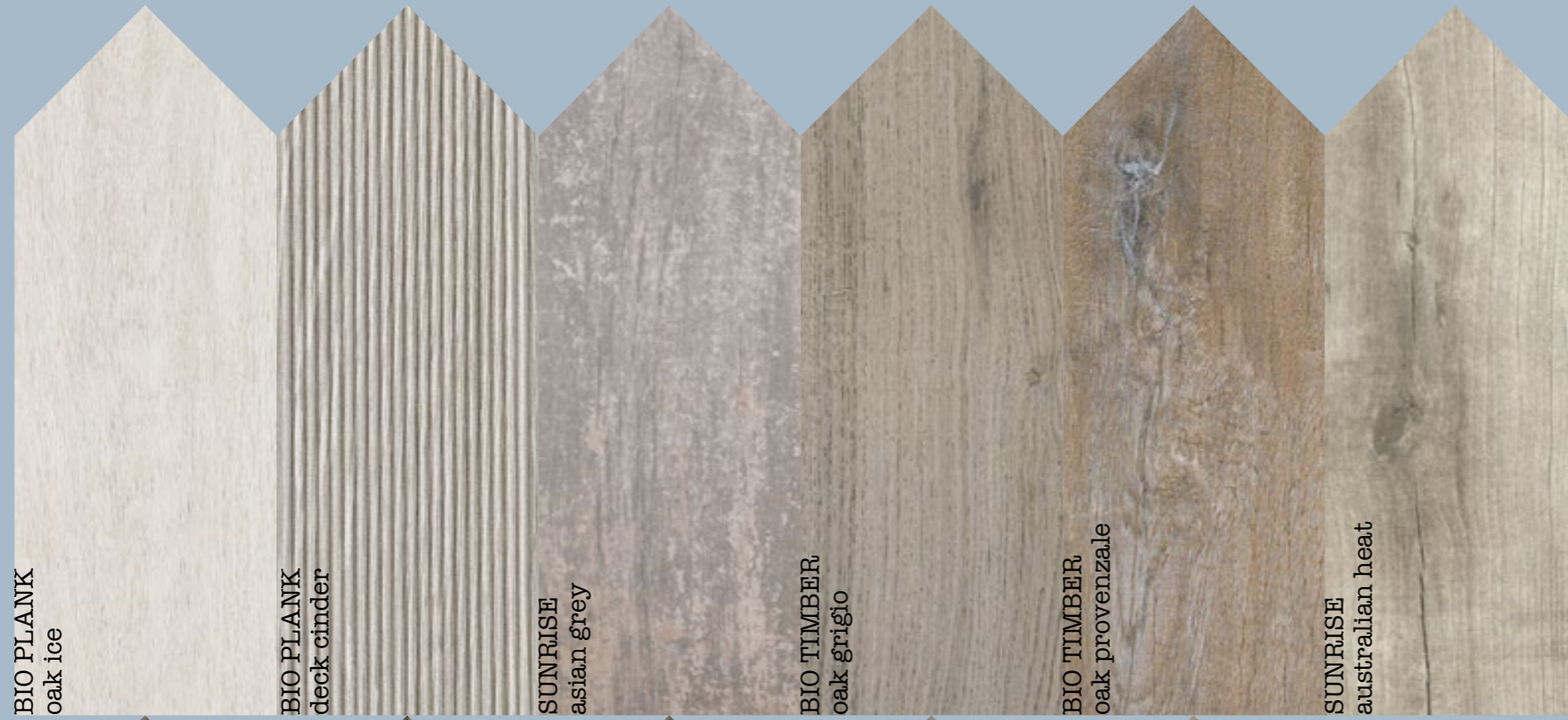

# I Colori Caldi.

\_The Warm Colors.

Cromie di base che virano al giallo, al rosa, al dorato. Le tonalità chiare, delicate e luminose, si affiancano ai toni più scuri, ai colori più carichi della terra. Da soli cambiano l'atmosfera di uno spazio.

Yellow, pink and gold are in this case the base colors. Light, delicate, luminous tones, combine with dark and earthy colors. They change the atmosphere of a space by themselves.







# I Colori Freddi.

\_The Cold Colors.

bio timber - oak grigio scuro  
20x120cm / 8"x48"



bio lumber - lodge grey  
20x120cm / 8"x48"



**bio plank - deck cinder**  
12x120cm / 4<sup>3</sup>/<sub>4</sub>"x48"



**bio plank - fumè**  
20x120cm / 8"x48"

wood-stock - vintage wood  
20x150cm / 8"x59"



sunrise - european dark  
20x90,5cm / 8"x36"





bio timber - oak grigio  
mosaico wall



bio timber - oak provenzale  
20x120cm / 8"x48"

sunrise - australian heat  
20x90,5cm / 8"x36"



sunrise - asian grey  
20x90,5cm / 8"x36"



# I Colori Caldi.

\_The Warm Colors.

wood-stock - cream wood  
33x300cm / 13"x118"



wood-stock - nut wood  
20x200cm / 8"x79"



wood-stock - nut wood  
20x150cm - 20x100cm / 8"x59" - 8"x39"





wood-stock - coffee wood  
20x200cm / 8"x79"



wood-stock - snow wood  
20x200cm / 8"x79"







bio timber - oak patinato scuro  
20x120cm / 8"x48"



**bio lumber - lodge brown**  
20x120cm / 8"x48"



**bio lumber - lodge greige**  
20x120cm / 8"x48"

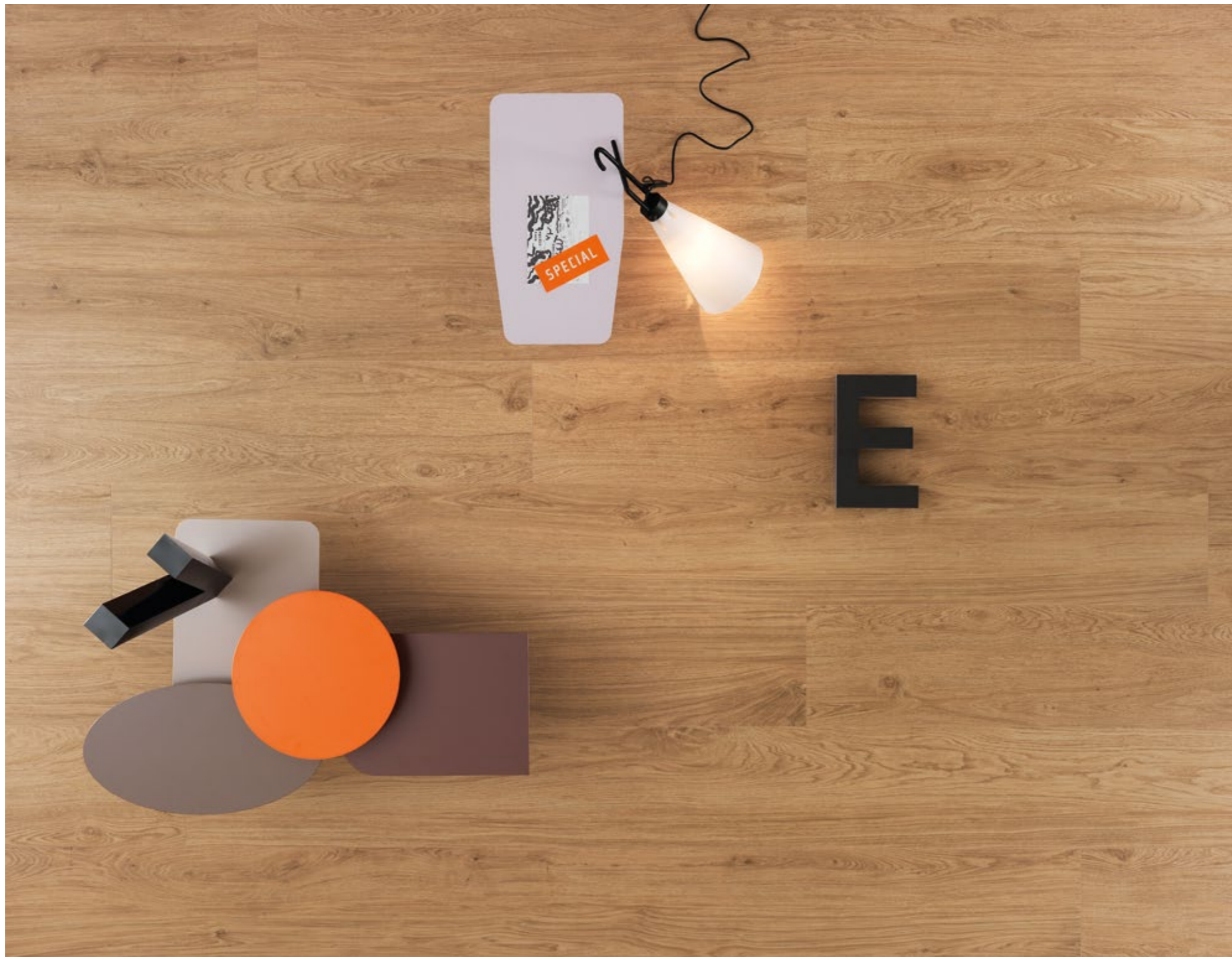





sunrise - african amber  
20x90,5cm / 8"x36"



**sunrise - american walnut**  
**20x90,5cm / 8"x36"**

bio plank - oak noisette  
20x120cm / 8"x48"



**SNOW WOOD**



\*33x300cm / 13"x118"  
slimtech 5plus

LS8WS45



20x200cm / 8"x79"  
slimtech 5plus

LSJWS45



20x150cm / 8"x59"  
slimtech 5plus

LSRWS45



20x100cm / 8"x39"  
slimtech 5plus

LS0WS45

**CREAM WOOD**



\*33x300cm / 13"x118"  
slimtech 5plus

LS8WS05



20x200cm / 8"x79"  
slimtech 5plus

LSJWS05



20x150cm / 8"x59"  
slimtech 5plus

LSRWS05



20x100cm / 8"x39"  
slimtech 5plus

LS0WS05

**NUT WOOD**



\*33x300cm / 13"x118"  
slimtech 5plus

LS8WS55



20x200cm / 8"x79"  
slimtech 5plus

LSJWS55



20x150cm / 8"x59"  
slimtech 5plus

LSRWS55



20x100cm / 8"x39"  
slimtech 5plus

LS0WS55

**HONEY WOOD**



\*33x300cm / 13"x118"  
slimtech 5plus

LS8WS15



20x200cm / 8"x79"  
slimtech 5plus

LSJWS15



20x150cm / 8"x59"  
slimtech 5plus

LSRWS15



20x100cm / 8"x39"  
slimtech 5plus

LS0WS15

\*per ordini inferiori alle 15 lastre sarà addebitato il costo del pallet a Euro 80,00 netto. - the cost of the pallet, Euro 80,00 net, will be charged for orders less than 15 slabs. - pour toutes commandes inférieures à 15 dalles, un cout de 80 Euro correspondant au cout de la palette sera ajouté. - bei Abnahme einer Menge unter 15 Platten werden Euro 80,00 Netto für Verpackung/palette belastet. - por pedidos inferiores a las 15 piezas adeudaremos el coste del palet de 80 Euro neto.

**VINTAGE WOOD**



\*33x300cm / 13"x118" slimtech 5plus LS8WS25



20x200cm / 8"x79" slimtech 5plus LSJWS25



20x150cm / 8"x59" slimtech 5plus LSRWS25



20x100cm / 8"x39" slimtech 5plus LS0WS25

**COFFEE WOOD**

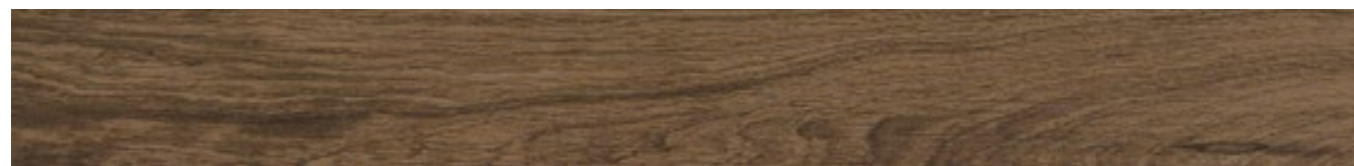

\*33x300cm / 13"x118" slimtech 5plus LS8WS35



20x200cm / 8"x79" slimtech 5plus LSJWS35



20x150cm / 8"x59" slimtech 5plus LSRWS35



20x100cm / 8"x39" slimtech 5plus LS0WS35

\*per ordini inferiori alle 15 lastre sarà addebitato il costo del pallet a Euro 80,00 netto. - the cost of the pallet, Euro 80,00 net, will be charged for orders less than 15 slabs. - pour toutes commandes inférieures à 15 dalles, un cout de 80 Euro correspondant au cout de la palette sera ajouté. - bei Abnahme einer Menge unter 15 Platten werden Euro 80,00 Netto für Verpackung/palette belastet. - por pedidos inferiores a las 15 piezas adeudaremos el coste del palet de 80 Euro neto.

**AUSTRALIAN HEAT**



20x90,5cm / 8"x36" LG3SR40

**ASIAN GREY**



20x90,5cm / 8"x36" LG3SR10

**AFRICAN AMBER**



20x90,5cm / 8"x36" LG3SR30

**EUROPEAN DARK**



20x90,5cm / 8"x36" LG3SR20

**AMERICAN WALNUT**



20x90,5cm / 8"x36" LG3SR00

**SUNRISE PEZZI SPECIALI**  
TRIMS\_PIECES SPÉCIALES\_FORMSTÜCKE

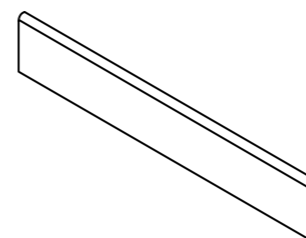

BATTISCOPA  
10x60,4cm / 4"x24"  
australian heat  
african amber  
asian grey  
european dark  
american walnut

LGBSR40  
LGBSR30  
LGBSR10  
LGBSR20  
LGBSR00

**LODGE GREIGE**



30x120cm / 12"x48"

LG6BL10



20x120cm / 8"x48"

LG7BL10

**LODGE BROWN**



30x120cm / 12"x48"

LG6BL00



20x120cm / 8"x48"

LG7BL00

**LODGE GREY**



30x120cm / 12"x48"

LG6BL20



20x120cm / 8"x48"

LG7BL20

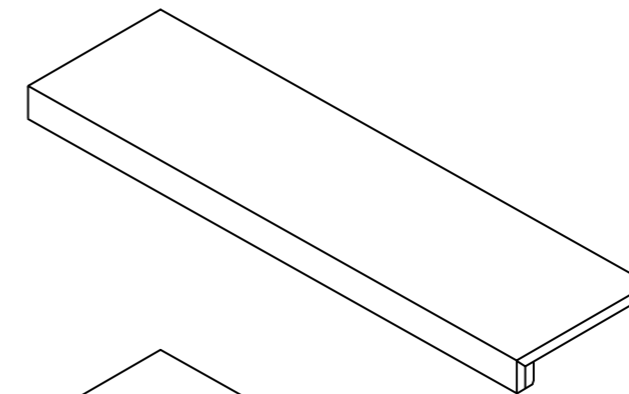

**ANGOLO SX GRADINO PLUS\***  
35x120cm / 13 3/4"x48"  
lodge greige  
lodge brown  
lodge grey

LG9BLS1  
LG9BLS0  
LG9BLS2

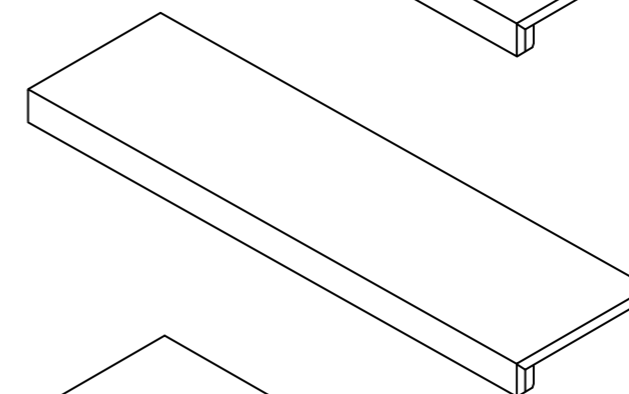

**GRADINO PLUS\***  
35x120cm / 13 3/4"x48"  
lodge greige  
lodge brown  
lodge grey

LG9BL10  
LG9BL00  
LG9BL20

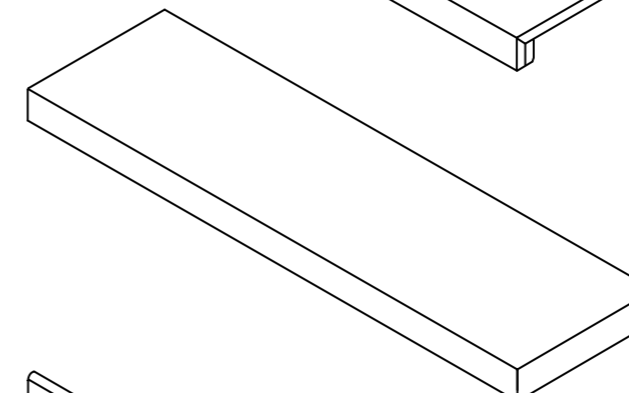
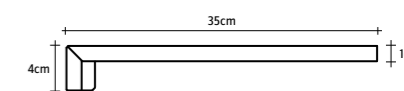

**ANGOLO DX GRADINO PLUS\***  
35x120cm / 13 3/4"x48"  
lodge greige  
lodge brown  
lodge grey

LG9BLD1  
LG9BLD0  
LG9BLD2

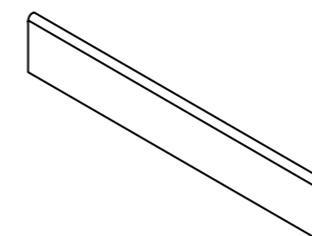

**BATTISCOPA**  
10x60cm / 4"x24"  
lodge greige  
lodge brown  
lodge grey

LG8BL10  
LG8BL00  
LG8BL20

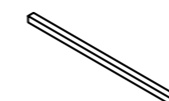

**RACCORDO JOLLY**  
1,3x30cm / 1/2"x12"  
lodge greige  
lodge brown  
lodge grey

LG9BL61  
LG9BL60  
LG9BL62



**BEAK JOLLY**  
1,3x2cm / 1/2"x3/4"  
lodge greige  
lodge brown  
lodge grey

LG9BL51  
LG9BL50  
LG9BL52

\*su richiesta. Per maggiori informazioni circa quantità minime e tempi di consegna rivolgersi all'ufficio commerciale. - upon request. For more information about minimum quantities and delivery times please contact the sales department. - sur demande. Pour plus d'informations sur les quantités minimales et délais de livraison s'il vous plaît contacter le département des ventes. - auf Anfrage. Für weitere Infos über die Mindestmengen und Lieferzeiten wenden Sie sich bitte an unserer Verkaufsabteilung. - bajo pedido. Para mayor información sobre la cantidad mínima y plazo de entrega contactar nuestra oficina comercial.

**OAK PATINATO CHIARO**



20x120cm / 8"x48"

LG7BI00

**OAK PATINATO SCURO**



20x120cm / 8"x48"

LG7BI10

**OAK PROVENZALE**



20x120cm / 8"x48"

LG7BI20

**OAK GRIGIO**



20x120cm / 8"x48"

LG7BI40

**OAK GRIGIO SCURO**



20x120cm / 8"x48"

LG7BI30



COMPASS  
20x120cm / 8"x48"  
oak patinato chiaro

LG7BIC0



COMPASS  
20x120cm / 8"x48"  
oak patinato scuro

LG7BIC1



COMPASS  
20x120cm / 8"x48"  
oak provenzale

LG7BIC2



COMPASS  
20x120cm / 8"x48"  
oak grigio

LG7BIC4



COMPASS  
20x120cm / 8"x48"  
oak grigio scuro

LG7BIC3



STRIP  
20x120cm / 8"x48"  
oak patinato chiaro

LG7BIS0



STRIP  
20x120cm / 8"x48"  
oak patinato scuro

LG7BIS1



STRIP  
20x120cm / 8"x48"  
oak provenzale

LG7BIS2



STRIP  
20x120cm / 8"x48"  
oak grigio

LG7BIS4



STRIP  
20x120cm / 8"x48"  
oak grigio scuro

LG7BIS3



**TRIANGLES**  
20x120cm / 8"x48"  
oak patinato chiaro

LG7BIT0



**TRIANGLES**  
20x120cm / 8"x48"  
oak patinato scuro

LG7BIT1

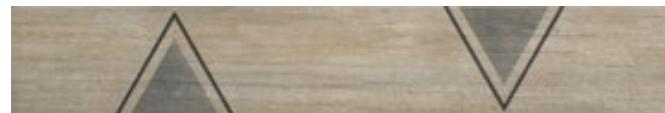

**TRIANGLES**  
20x120cm / 8"x48"  
oak provenzale

LG7BIT2



**TRIANGLES**  
20x120cm / 8"x48"  
oak grigio

LG7BIT4



**TRIANGLES**  
20x120cm / 8"x48"  
oak grigio scuro

LG7BIT3



**MOSAICO WALL**  
31x31cm / 12 1/4"x12 1/4"  
oak patinato chiaro LG9BIM0



**MOSAICO WALL**  
31x31cm / 12 1/4"x12 1/4"  
oak patinato scuro LG9BIM1



**MOSAICO WALL**  
31x31cm / 12 1/4"x12 1/4"  
oak provenzale LG9BIM2



**MOSAICO WALL**  
31x31cm / 12 1/4"x12 1/4"  
oak grigio LG9BIM4



**MOSAICO WALL**  
31x31cm / 12 1/4"x12 1/4"  
oak grigio scuro LG9BIM3

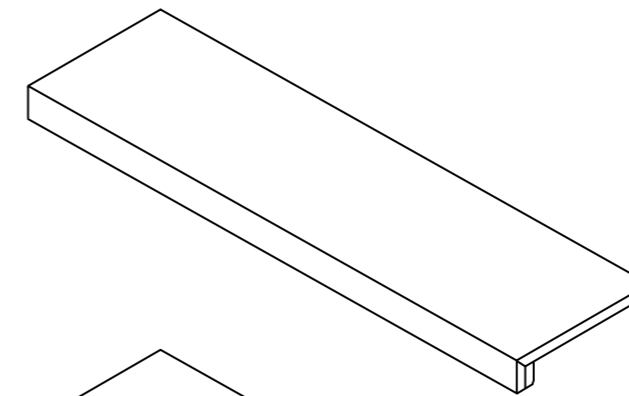

**ANGOLO SX GRADINO PLUS\***  
35x120cm / 13 3/4"x48"  
oak patinato chiaro  
oak patinato scuro  
oak provenzale  
oak grigio  
oak grigio scuro

LG9BIS0  
LG9BIS1  
LG9BIS2  
LG9BIS4  
LG9BIS3

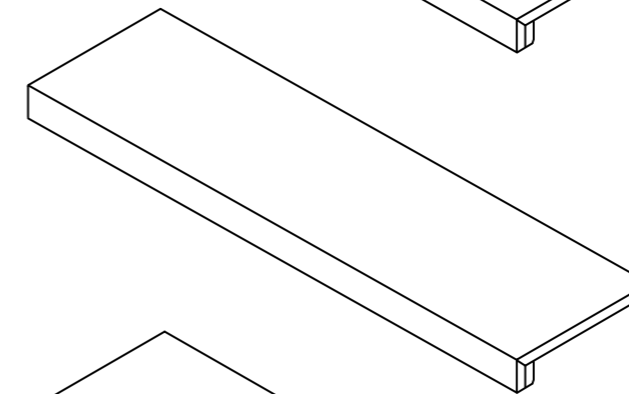

**GRADINO PLUS\***  
35x120cm / 13 3/4"x48"  
oak patinato chiaro  
oak patinato scuro  
oak provenzale  
oak grigio  
oak grigio scuro

LG9BIG0  
LG9BIG1  
LG9BIG2  
LG9BIG4  
LG9BIG3

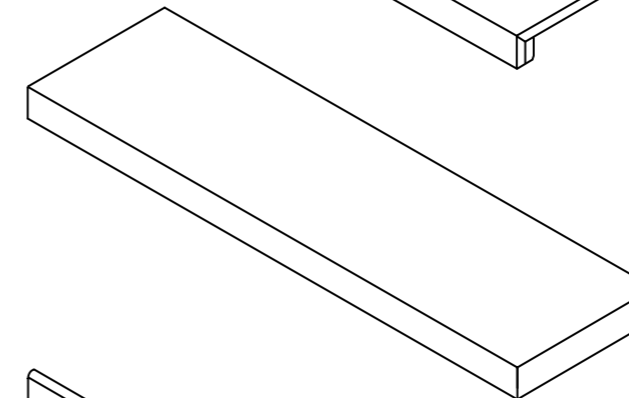

**ANGOLO DX GRADINO PLUS\***  
35x120cm / 13 3/4"x48"  
oak patinato chiaro  
oak patinato scuro  
oak provenzale  
oak grigio  
oak grigio scuro

LG9BID0  
LG9BID1  
LG9BID2  
LG9BID4  
LG9BID3

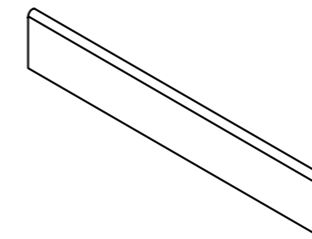

**BATTISCOPA**  
10x60cm / 4"x24"  
oak patinato chiaro  
oak patinato scuro  
oak provenzale  
oak grigio  
oak grigio scuro

LG8BI00  
LG8BI10  
LG8BI20  
LG8BI40  
LG8BI30

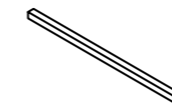

**RACCORDO JOLLY**  
1,3x30cm / 1/2"x12"  
oak patinato chiaro  
oak patinato scuro  
oak provenzale  
oak grigio  
oak grigio scuro

LG9BIJ0  
LG9BIJ1  
LG9BIJ2  
LG9BIJ4  
LG9BIJ3



**BEAK JOLLY**  
1,3x2cm / 1/2"x3/4"  
oak patinato chiaro  
oak patinato scuro  
oak provenzale  
oak grigio  
oak grigio scuro

LG9BIK0  
LG9BIK1  
LG9BIK2  
LG9BIK4  
LG9BIK3

\*su richiesta. Per maggiori informazioni circa quantità minime e tempi di consegna rivolgersi all'ufficio commerciale. - upon request. For more information about minimum quantities and delivery times please contact the sales department. - sur demande. Pour plus d'informations sur les quantités minimales et délais de livraison s'il vous plaît contacter le département des ventes. - auf Anfrage. Für weitere Infos über die Mindestmengen und Lieferzeiten wenden Sie sich bitte an unserer Verkaufsabteilung. - bajo pedido. Para mayor información sobre la cantidad mínima y plazo de entrega contactar nuestra oficina comercial.



**OAK ICE**



20x120cm / 8"x48"

LG7BP30

**DECORO FENCE OAK ICE\***



20x120cm / 8"x48"

LG7BPF3

**OAK NOISSETTE**



20x120cm / 8"x48"

LG7BP40

**DECORO FENCE OAK NOISSETTE\***



20x120cm / 8"x48"

LG7BPF4

**FUMÈ**



20x120cm / 8"x48"

LG7BP50

**DECORO FENCE FUMÈ\***

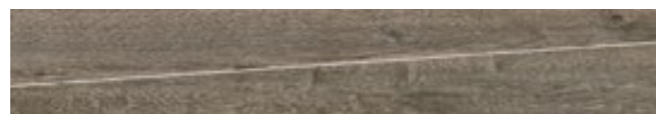

20x120cm / 8"x48"

LG7BPF5

**DECK CINDER\*\***



12x120cm / 4 3/4"x48"

LG7BP70

**DECK BROWN\*\***



12x120cm / 4 3/4"x48"

LG7BP90

**DECK FUMÈ\*\***



12x120cm / 4 3/4"x48"

LG7BP80

\*\*non trattato con antibatterico  
without antimicrobial treatment  
sans traitement antibacterien  
nicht mit antibakterieller  
Wirkung ausgestattet

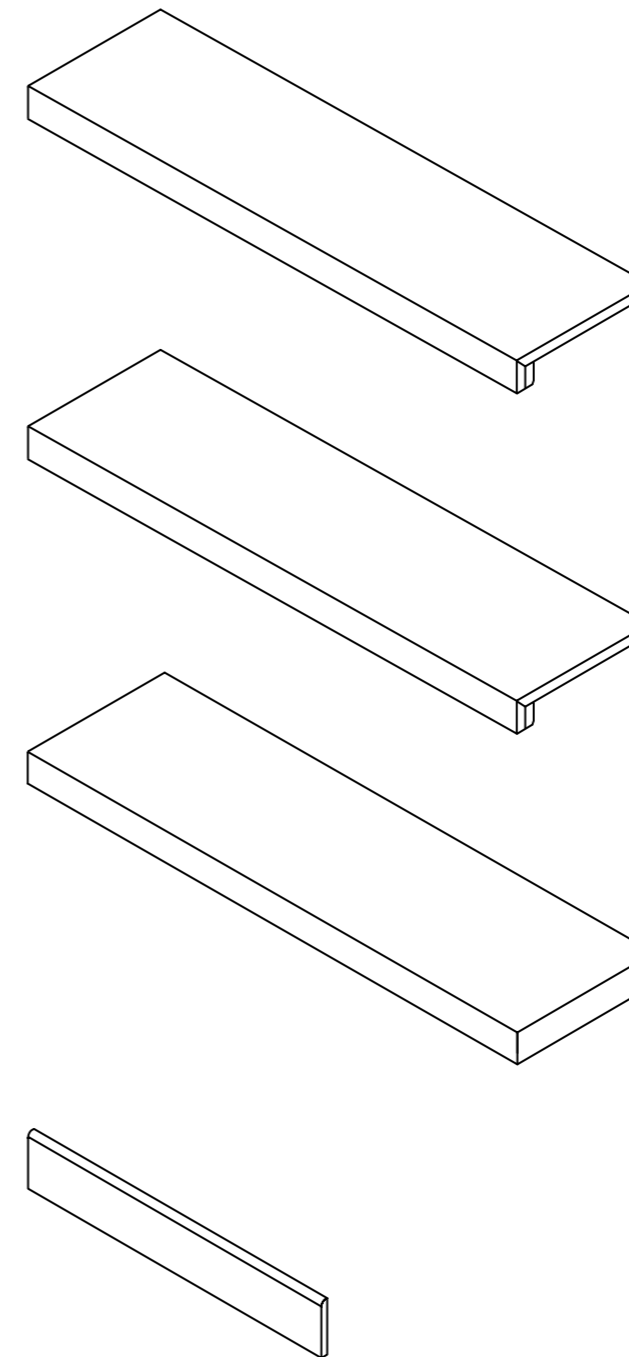

**ANGOLO SX GRADINO PLUS\***  
35x120cm / 13 3/4"x48"  
fumè  
oak noisette  
oak ice

LG9BPS5  
LG9BPS4  
LG9BPS3

**GRADINO PLUS\***  
35x120cm / 13 3/4"x48"  
fumè  
oak noisette  
oak ice

LG9BPP5  
LG9BPP4  
LG9BPP3

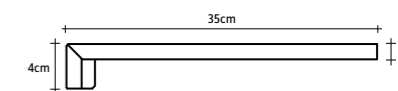

















**ANGOLO DX GRADINO PLUS\***  
35x120cm / 13 3/4"x48"  
fumè  
oak noisette  
oak ice









LG9BPD5  
LG9BPD4  
LG9BPD3

**BATTISCOPA**  
10x60cm / 4"x24"  
fumè  
oak noisette  
oak ice

LG8BPB5  
LG8BPB4  
LG8BPB3

\*su richiesta. Per maggiori informazioni circa quantità minime e tempi di consegna rivolgersi all'ufficio commerciale. - upon request. For more information about minimum quantities and delivery times please contact the sales department. - sur demande. Pour plus d'informations sur les quantités minimales et délais de livraison s'il vous plaît contacter le département des ventes. - auf Anfrage. Für weitere Infos über die Mindestmengen und Lieferzeiten wenden Sie sich bitte an unserer Verkaufsabteilung. - bajo pedido. Para mayor información sobre la cantidad mínima y plazo de entrega contactar nuestra oficina comercial.

		BIO LUMBER	SUNRISE	BIO TIMBER	BIO PLANK	
	<b>gres tutta massa UGL</b> full-body porcelain grès cérame en pleine masse vollgemischtes durchgefärbtes feisteinzeug					
	<b>caratteristiche tecniche*</b> <b>technical characteristics</b> <b>caractéristiques techniques</b> <b>technische eigenschaften</b>	<b>metodo di prova</b> <b>test method</b> <b>methode d'essai</b> <b>prufmethode</b>	<b>fondi plain tile</b> <b>fond</b> <b>unifliese</b>	<b>fondi plain tile</b> <b>fond</b> <b>unifliese</b>	<b>fondi plain tile</b> <b>fond</b> <b>unifliese</b>	<b>fondi plain tile</b> <b>fond</b> <b>unifliese</b>
	<b>assorbimento d'acqua (E)</b> water absorption (E) absorption d'eau (E) wasserabsorption (E)	iso 10545-3	≤ 0,04%	≤ 0,04%	≤ 0,04%	≤ 0,04%
	<b>resistenza al gelo</b> frost resistance résistance au gel frostbeständigkeit	iso 10545-12	resistente résistant beständig	resistente résistant beständig	resistente résistant beständig	resistente résistant beständig
	<b>resistenza alla flessione</b> bending strength résistance à la flexion beigefestigkeit	iso 10545-4	≥ 50 N/mm <sup>2</sup>	≥ 50 N/mm <sup>2</sup>	≥ 50 N/mm <sup>2</sup>	≥ 50 N/mm <sup>2</sup>
	<b>sforzo di rottura (S)</b> breaking strength (S) chargement de rupture (S) bruchlast (S)	iso 10545-4	≥ 2500 N	≥ 2500 N	≥ 3000 N	≥ 3000 N
	<b>resistenza all'abrasione profonda</b> résistance to deep abrasion résistance à l'abrasion profonde widerstand gegen tiefenabrier	iso 10545-6	≤ 145 mm <sup>3</sup>	≤ 145 mm <sup>3</sup>	≤ 145 mm <sup>3</sup>	≤ 145 mm <sup>3</sup>
	<b>dilatazione termica lineare</b> thermal expansion dilatation thermique linéaire thermische dilatation	iso 10545-8	α≤7x10 <sup>-6</sup> °C <sup>-1</sup>	α≤7x10 <sup>-6</sup> °C <sup>-1</sup>	α≤7x10 <sup>-6</sup> °C <sup>-1</sup>	α≤7x10 <sup>-6</sup> °C <sup>-1</sup>
	<b>resistenza agli sbalzi termici</b> thermal shock resistance résistance aux chocs thermiques temperatur wechselbeständigkeit	iso 10545-9	resistente résistant beständig	resistente résistant beständig	resistente résistant beständig	resistente résistant beständig
	<b>resistenza attacco chimico</b> chemical resistance résistance chimique chemischee beständigkeit	iso 10545-13	uha, ula resistente résistant beständig	uha, ula resistente résistant beständig	uha, ula resistente résistant beständig	uha, ula resistente résistant beständig
	<b>resistenza alle macchie</b> stain resistance résistance aux taches fleckenbeständigkeit	iso 10545-14	5 resistente résistant beständig	5 resistente résistant beständig	5 resistente résistant beständig	5 resistente résistant beständig
	<b>resistenza allo scivolamento</b> slip resistance résistance au glissement rutschfestigkeit	din 51130	r10	r10	r9	r9 (nat.) r11 (deck)
	<b>resistenza allo scivolamento</b> slip resistance résistance au glissement rutschfestigkeit	din 51097	B (A+B)	B (A+B)	-	C (A+B+C) (deck)
	<b>coefficiente di attrito dinamico</b> dynamic friction coefficient coefficient de friction dynamique dynamischer reibungskoeffizient	B.C.R. tortus	μ>0,40	μ>0,40	μ>0,40	μ>0,40
	<b>dynamic coefficient of friction (DCOF)</b>	ANSI A 137.1:2012 (BOT 3000)	DCOF≥0.42	DCOF≥0.42	DCOF≥0.42	DCOF≥0.42
	<b>wet pendulum test AUS</b>	AS 4586:2013	class P3(X)	-	-	-
	<b>pendulum test UK</b>	BS 7976:2002	slider 96 wet: 36+	-	-	slider 96 wet: 36+ (deck) slider 55 wet: 36+ (deck)
	<b>stonalizzazione</b> shading denuançage spieľfarbig		V4	V4	V3	V3

	<b>impieghi uses</b> <b>emploi</b> <b>anwendungsbereiche</b>
	<b>alberghi</b> hotels hotels hotels
	<b>locali pubblici</b> public spaces lieux publics öffentliche bereiche
	<b>abitazioni</b> housing maisons wohnbereiche
	<b>aeroporti</b> airports aéroports flughafen
	<b>bar - ristoranti</b> bar - restaurants bar - restaurants cafés - restaurants, gasthäuser
	<b>centri commerciali</b> malls centre commerciaux einkaufszentren
	<b>negozi</b> shops magasins geschäfte
	<b>stazioni</b> train stations gares bahnhöfe

Le rappresentazioni fotografiche e descrittive dei prodotti di Lea Ceramiche riportate sui depliant, sui cataloghi e sugli altri materiali pubblicitari dell'azienda, sono puramente illustrative dello specifico prodotto rappresentato. Si precisa infatti che, successivamente alla pubblicazione dei materiali pubblicitari dell'azienda, il prodotto potrebbe subire leggere modifiche nel relativo processo produttivo, al fine di renderlo tecnologicamente migliore. Tali aggiustamenti tecnologici potrebbero determinare lievi differenze, anche estetiche e/o cromatiche, nel prodotto medesimo, con la conseguenza che lo stesso potrebbe risultare diverso da come rappresentato e/o illustrato e/o descritto nel materiale pubblicitario di Lea Ceramiche. Tali differenze non potranno essere in alcun modo considerate dall'acquirente un vizio e/o difetto del materiale ceramico stesso, bensì una caratteristica dello specifico prodotto. Tutti i materiali ceramici che imitano pietre naturali presentano differenze di colore e sfumature che non potranno in nessun modo essere considerate quale difetto del prodotto, ma bensì una qualità caratteristica di tali tipi di produzione.

The photographs and descriptions of Lea Ceramiche products given in the brochures, catalogues and other corporate advertising materials aim merely to represent the specific products. After the publication of the corporate advertising materials, the products may be slightly modified as a result of technological improvements. Such technological modifications may lead to slight differences in appearance and/or colour of the products, which may therefore differ from the representations, illustrations or descriptions given in the Lea Ceramiche advertising materials. Such differences shall in no way be deemed to be faults and/or defects in the ceramic materials, but rather intrinsic features of the specific products. All ceramic materials that imitate natural stone differ in color and nuances, and this cannot in any way be considered as a product defect, but rather a characteristic of these types of products.

## SLIMTECH

### WOOD-STOCK

**gres laminato UGL**  
laminated porcelain UGL  
grès laminé UGL  
laminiertes feinsteinzeug UGL















**spessore 5,5mm**  
thickness  
épaisseur  
stärke

**caratteristiche tecniche\***  
**technical characteristics**  
**caractéristiques techniques**  
**technische eigenschaften**

**metodo di prova**  
**test method**  
**methode d'essai**  
**prüfmethode**

**requisiti prescritti**  
**required values / valeurs requises**  
**vorgeschriebener wert**  
**iso 13006 - G / en 14411 - G**  
**B1a ugl**

**fondi**  
**plain tile**  
**fond**  
**unifliese**

	<b>assorbimento d'acqua</b> water absorption absorption d'eau wasserabsorption	iso 10545-3	≤ 0,5%	≤ 0,1%*
	<b>resistenza al gelo</b> frost resistance résistance au gel frostbeständigkeit	iso 10545-12	nessuna alterazione no alterations	resistente resistant
	<b>resistenza alla flessione</b> bending strength résistance à la flexion beigefestigkeit	iso 10545-4	≥ 35 N/mm <sup>2</sup>	≥ 55 N/mm <sup>2**</sup>
	<b>sforzo di rottura (S)</b> breaking strength (S) chargement de rupture (S) bruchlast (S)	iso 10545-4	≥ 700 N	≥ 1200 N**
	<b>resistenza all'abrasione profonda</b> résistance to deep abrasion résistance à l'abrasion profonde widerstand gegen tiefenabrier	iso 10545-6	≤ 175 mm <sup>3</sup>	conforme compliant
	<b>resistenza a compressione</b> resistance to compression résistance à la compression druckfestigkeit	-	-	≥ 400 N/mm <sup>2</sup>
	<b>dilatazione termica lineare</b> thermal expansion dilatation thermique linéaire thermische dilatation	iso 10545-8	requisito non previsto iso makes no provision for this test	α≤7x10 <sup>-6</sup> °C <sup>-1</sup>
	<b>resistenza agli sbalzi termici</b> thermal shock resistance résistance aux chocs thermiques temperatur wechselbeständigkeit	iso 10545-9	resistente resistant	resistente resistant
	<b>resistenza attacco chimico</b> chemical resistance résistance chimique chemischee beständigkeit	iso 10545-13	come indicato dal produttore as indicated by manufacturer	uha, ula (resistente) resistant
	<b>resistenza alle macchie</b> stain resistance résistance aux taches fleckenbeständigkeit	iso 10545-14	≥ classe 3 ≥ class 3	classe 5 (resistente) resistant
	<b>resistenza allo scivolamento</b> slip resistance résistance au glissement rutschfestigkeit	din 51130	r10 10° < α ≤ 19°	r10
	<b>coefficiente di attrito dinamico</b> dynamic friction coefficient coefficient de friction dynamique dynamischer reibungskoeffizient	B.C.R. tortus	μ > 0,40 L. 13/89 - DM. 236/89 D. Lgs 503/96	μ > 0,40 cuoio - asciutto gomma - bagnato
	<b>dynamic coefficient of friction (DCOF)</b>	ANSI A 137.1:2012 (BOT 3000)	DCOF ≥ 0.42	DCOF ≥ 0.42
	<b>stonalizzazione</b> shading denuançage spielfarbig			V2



**wood-stock - cream wood**  
**33x300cm / 13"x118"**

\*VALORE MEDIO RIFERITO AL MATERIALE CERAMICO  
AVERAGE VALUE REFERRED TO CERAMIC MATERIAL ONLY

\*\*VALORE MEDIO RIFERITO AL PEZZO COMPLETO (LASTRA E RINFORZO)  
AVERAGE VALUE REFERRED TO THE ALL-IN-ONE PIECE (SLAB AND FIBERGLASS)

ITA



**POSA A PAVIMENTO**

Situazioni applicative sia per interventi di NUOVA COSTRUZIONE che di RISTRUTTURAZIONI con posa in sovrapposizione a pavimenti preesistenti.

**RESIDENZIALE** (cucine, bagni, living, aree comuni condominiali ed ogni altro ambiente di uso residenziale).  
**slimtech 5plus**



**COMMERCIALE LEGGERO** (uffici, uffici aperti al pubblico, sale d'attesa, negozi, bagni, sale di ristoranti, autosaloni, bar, cinema, ambulatori/cliniche).  
**slimtech 5plus**

**COMMERCIALE INTENSIVO** (aree comuni di centri commerciali, hall di alberghi, mense, fast food, discoteche, ospedali) ad esclusione di zone sottoposte al passaggio di carichi pesanti concentrati (ad es. carrelli a ruote dure).  
**slimtech 5plus**



A condizione che le superfici siano coperte (es. loggie, balconi coperti, ecc.) e perfettamente impermeabilizzate. Si consiglia l'utilizzo di formati non superiori a 50x50 cm.  
**slimtech 5plus**



**POSA A PARETE**

Situazioni applicative sia per interventi di NUOVA COSTRUZIONE che di RISTRUTTURAZIONI con posa in sovrapposizione a rivestimenti preesistenti.

Qualunque ambiente residenziale e commerciale, in situazioni dove **non** si devono praticare fori e/o tagli interni.  
**slimtech 5plus**



Qualunque ambiente residenziale e commerciale, in situazioni dove si devono praticare fori e/o tagli interni.  
**slimtech 5plus**



In situazioni dove **non** si devono praticare fori e/o tagli interni e con formati fino a 100x100 cm.  
**slimtech 5plus**

In situazioni dove si devono praticare fori e/o tagli interni e/o per formati grandi.  
**slimtech 5plus**

**DESTINAZIONI SPECIALI**

In funzione delle specifiche del progetto, in abbinamento a sistemi costruttivi indicati da Panariagroup e approvati dalla Direzione Lavori.



**FACCIAE VENTILATE**  
**slimtech 5plus**



**RIVESTIMENTI TERMICI A CAPPOTTO**  
**slimtech 5plus**



**RIVESTIMENTI VASCHE E PISCINE**  
**slimtech 5plus**



**SUPERFICI DA RIVESTIRE NEL SETTORE DELL'ARREDAMENTO**  
**slimtech 5plus**

ENG

**FLOOR INSTALLATION**

For NEW BUILDINGS and REFURBISHING, for installation on pre-existing floors.

**RESIDENTIAL** (kitchens, bathrooms, living rooms, common apartment block areas and any other residential environment).  
**slimtech 5plus**

INTERIORS

**LIGHT COMMERCIAL** (offices, offices open to the general public, waiting rooms, shops, bathrooms, restaurant dining rooms, car showrooms, bars, cinemas, surgeries/clinics).  
**slimtech 5plus**

**INTENSIVE COMMERCIAL** (common areas of shopping centres, hotel halls, canteens, fast food restaurants, dance clubs, hospitals) with the exception of areas subject to heavy concentrated loads (e.g. trolleys with hard wheels).  
**slimtech 5plus**

EXTERIORS

Upon condition that surfaces are sheltered (e.g. loggias, covered balconies, etc.) and made totally impervious. The use of sizes that are not larger than 50x50cm is recommended.  
**slimtech 5plus**

**WALL INSTALLATION**

For NEW BUILDINGS and REFURBISHING, for installation on pre-existing walls.

Any residential and commercial environment, in situations where holes and/or cuts are **not** necessary.  
**slimtech 5plus**

INTERIORS

Any residential and commercial environment, in situations where holes and/or cuts are necessary.  
**slimtech 5plus**

EXTERIORS

In situations where holes and/or cuts are **not** necessary and with sizes up to 100 x 100 cm.  
**slimtech 5plus**

In situations where holes and/or cuts are necessary and/or for large sizes.  
**slimtech 5plus**

**SPECIAL USES**

Depending on project specifications and in combination with the construction systems recommended by Panariagroup and approved by the Installation Supervisor.

**VENTILATED FACADES**  
**slimtech 5plus**

**THERMAL INSULATION SYSTEMS**  
**slimtech 5plus**

**POOL AND SWIMMING POOL TILING**  
**slimtech 5plus**

**FOR FURNITURE SURFACES**  
**slimtech 5plus**

FRA

**POSE AU SOL**

Application dans des NOUVELLES CONSTRUCTIONS ou des RESTRUCTURATIONS, avec pose sur des sols préexistants.

**RÉSIDENTIEL** (cuisines, salles de bains, salles de séjour, zones de copropriété collectives et tout autre espace à usage résidentiel).  
**slimtech 5plus**

EN INTÉRIEUR

**COMMERCIAL LÉGER** (bureaux, bureaux ouverts au public, salles d'attente, magasins, salles de bains, salles de restaurants, salons automobiles, bars, cinémas, dispensaires/cliniques).  
**slimtech 5plus**

**COMMERCIAL INTENSIF** (zones communes de centres commerciaux, halls d'hôtels, cantines, fast-foods, discothèques, hôpitaux, sauf les zones soumises au passage de charges lourdes concentrées (ex. : chariots à roues dures).  
**slimtech 5plus**

EN EXTÉRIEUR

À condition que les surfaces soient couvertes (loggias, balcons couverts, etc.) et parfaitement imperméabilisées. Il est conseillé d'utiliser des formats non supérieurs à 50x50 cm.  
**slimtech 5plus**

**POSE AU MUR**

Application dans des NOUVELLES CONSTRUCTIONS ou des RESTRUCTURATIONS, avec pose sur des supports préexistants.

Tout espace résidentiel et commercial, dans des endroits où **il n'est pas** nécessaire d'effectuer des trous et/ou des découpes internes.  
**slimtech 5plus**

EN INTÉRIEUR

Tout espace résidentiel et commercial, dans des endroits où il est nécessaire d'effectuer des trous et/ou des découpes internes.  
**slimtech 5plus**

EN EXTÉRIEUR

Dans les situations où **il ne faut pas** percer de trous ni pratiquer de découpes internes et avec des formats jusqu'à 100x100 cm.  
**slimtech 5plus**

Dans les situations où il faut percer des trous ou pratiquer des découpes internes ou pour de grands formats.  
**slimtech 5plus**

**UTILISATIONS SPÉCIALES**

En fonction des caractéristiques du projet et en combinaison avec les systèmes de construction indiqués par Panariagroup et approuvés par les maîtres d'oeuvre.

**FAÇADES VENTILÉES**  
**slimtech 5plus**

**REVÊTEMENTS THERMIQUES À MUR-MANTEAU**  
**slimtech 5plus**

**REVÊTEMENTS BAIGNOIRES ET PISCINES**  
**slimtech 5plus**

**SURFACES À REVÊTIR DANS LE SECTEUR DE LA DÉCORATION**  
**slimtech 5plus**

DEU

**FUSSBODENVERLEGUNG**

Anwendungslösungen sowohl für NEUBAUTEN als auch für RENOVIERUNGEN mit Verlegung auf vorhandenen Bodenbelägen.

**WOHNBEREICHE** (Küchen, Badezimmer, Wohnzimmer, Gemeinschaftsflächen in Mehrfamilienhäusern und alle sonstigen Wohnbereiche).  
**slimtech 5plus**

INNENBEREICH

**LEICHTE GEWERBLICHE ANWENDUNGEN** (Büroräume, öffentliche Büros, Wartezimmer, Geschäfte, Toiletten, Gaststätten, Autohäuser, Cafés, Kinos, Praxen/Kliniken).  
**slimtech 5plus**

**INTENSIVE GEWERBLICHE ANWENDUNGEN** (gemeinschaftsbereiche in einkaufszentren, hotelhallen, kantinen, fastfood-restaurants, diskotheken, krankenhäuser), mit ausnahme von bereichen mit schwerlastverkehr (z.b. stapler mit hartgummirädern).  
**slimtech 5plus**

AUSSENBEREICH

Die Verlegung in Außenbereichen ist möglich, wenn die Oberflächen überdacht und vollkommen abgedichtet sind (überdachte Balkons, Veranden, usw.). Es sollten keine größeren Formate als 50x50 cm verwendet werden.  
**slimtech 5plus**

**WANDVERLEGUNG**

Anwendungslösungen sowohl für NEUBAUTEN als auch für RENOVIERUNGEN mit Verlegung auf vorhandenen Wandverkleidungen.

INNENBEREICH

Alle Wohn- und Gewerbebereiche, in Situationen, die keine Bohrungen und/oder Innenschnitte verlangen.  
**slimtech 5plus**

Alle Wohn- und Gewerbebereiche, in Situationen, die Bohrungen und/oder Innenschnitte verlangen.  
**slimtech 5plus**

AUSSENBEREICH

In Situationen, in denen keine internen Bohrungen und/oder Schnitte gefertigt werden müssen und mit Formaten bis 100x100 cm.  
**slimtech 5plus**

In Situationen, in denen interne Bohrungen und/oder Schnitte gefertigt werden müssen und/oder für Großformate.  
**slimtech 5plus**

**SPEZIELLE VERWENDUNGSZWECKE**

In Funktion der Projektangaben und in Kombination mit Konstruktionssystemen, die Panariagroup vorgibt und die Arbeitsleitung genehmigt.

**HINTERLÜFTETE FASSADEN**  
**slimtech 5plus**

**WÄRMEDÄMMVERBUNDSYSTEME**  
**slimtech 5plus**

**VERKLEIDUNG VON BECKEN UND SCHWIMMBECKEN**  
**slimtech 5plus**

**FLÄCHEN, DIE IM RAHMEN DER INNENEINRICHTUNG VERKLEIDET WERDEN**  
**slimtech 5plus**

ESP

**COLOCACIÓN EN PISO**

Situaciones aplicativas para obras de NUEVA CONSTRUCCIÓN o REFORMA con colocación superpuesta a pisos preexistentes.

**RESIDENCIAL** (cocinas, baños, salas de estar, áreas comunes en condominios y cualquier otro ambiente residencial).  
**slimtech 5plus**

EN INTERIORES

**COMERCIAL LIGERO** (oficinas, oficinas abiertas al público, salas de espera, tiendas, baños, salas de restaurantes, salones de automóviles, bares, cines, ambulatorios, clínicas).  
**slimtech 5plus**

**COMERCIAL INTENSIVO** (áreas comunes de centros comerciales, vestíbulos de hoteles, comedores, fast food, discotecas, hospitales), excluyendo las zonas sometidas al tránsito de cargas pesadas concentradas (por ej., carros de ruedas duras).  
**slimtech 5plus**

EN EXTERIORES

Con la condición de que las superficies estén cubiertas (ej. galerías, balcones cubiertos, etc.) y perfectamente impermeabilizadas. Se recomienda utilizar formatos no superiores a 50x50 cm.  
**slimtech 5plus**

**COLOCACIÓN EN PARED**

Situaciones aplicativas para obras de NUEVA CONSTRUCCIÓN o REFORMA con colocación superpuesta a revestimientos preexistentes.

EN INTERIORES

Cualquier ambiente residencial o comercial, en situaciones donde no se deben realizar orificios y/o cortes internos.  
**slimtech 5plus**

Cualquier ambiente residencial o comercial, en situaciones donde se deben realizar orificios y/o cortes internos.  
**slimtech 5plus**

EN EXTERIORES

En situaciones donde **no** se deben realizar orificios y/o cortes internos y con formatos de hasta 100x100 cm.  
**slimtech 5plus**

En situaciones donde se deben realizar orificios y/o cortes internos y/o para formatos grandes.  
**slimtech 5plus**

**DESTINOS ESPECIALES**

Según las especificaciones del proyecto, en combinación con sistemas constructivos indicados por Panariagroup y aprobados por la dirección de obras.

**FACHADAS VENTILADAS**  
**slimtech 5plus**

**REVESTIMIENTOS CON AISLAMIENTO TÉRMICO EXTERIOR**  
**slimtech 5plus**

**REVESTIMIENTOS DE BAÑERAS Y PISCINAS**  
**slimtech 5plus**

**SUPERFICIES A REVESTIR EN EL SECTOR DE LA DECORACIÓN**  
**slimtech 5plus**

**WOOD-STOCK**

articolo	scatola			europallet		
	pz.	mq	kg	scat.	mq	kg
fondo 5plus 33x300 13"x118"	1	0,99	12,5	24	23,8	299,7
fondo 5plus 20x200 8"x79"	3	1,20	15,0	40	48,0	600,0
fondo 5plus 20x150 8"x59"	3	0,90	11,3	60	54,0	675,0
fondo 5plus 20x100 8"x39"	3	0,60	7,5	60	36,0	450,0

**SUNRISE**

articolo	scatola			europallet		
	pz.	mq	kg	scat.	mq	kg
fondo 20x90,5 8"x36"	6	1,09	22,4	48	52,1	1075,2
battiscopa 10x60 4"x24"	16	9,7 m.l.	20,7	48	464,0 m.l.	993,6

**BIO LUMBER**

articolo	scatola			europallet		
	pz.	mq	kg	scat.	mq	kg
fondo 30x120 12"x48"	3	1,08	25,5	32	34,6	816,0
fondo 20x120 8"x48"	5	1,20	27,8	24	28,8	666,0
battiscopa 10x60 4"x24"	12	7,2 m.l.	18,0	60	432,0 m.l.	1080,0
gradino plus 35x120 13 3/4"x48"	2	0,84	23,2	24	20,2	556,8
angolo gradino plus 35x120 13 3/4"x48"	1	0,42	12,0	24	10,1	288,0
raccordo jolly 1,3x30 1/2"x12"	16	-	1,3	-	-	-
beak jolly 1,3x2 1/2"x3/4"	4	-	0,1	-	-	-

**BIO TIMBER**

articolo	scatola			europallet		
	pz.	mq	kg	scat.	mq	kg
fondo 20x120 8"x48"	5	1,20	30,6	24	28,8	734,4
compass 20x120 8"x48"	2	0,48	12,3	54	25,9	661,5
strip 20x120 8"x48"	2	0,48	12,3	54	25,9	661,5
triangles 20x120 8"x48"	2	0,48	12,3	54	25,9	661,5
mosaico wall 31x31 12 1/4"x12 1/4"	4	0,38	9,8	60	23,1	588,0
battiscopa 10x60 4"x24"	12	7,2 m.l.	18,0	56	403,0 m.l.	1008,0
gradino plus 35x120 13 3/4"x48"	2	0,84	23,2	24	20,2	556,8
angolo gradino plus 35x120 13 3/4"x48"	1	0,42	12,4	24	10,1	297,6
raccordo jolly 1,3x30 1/2"x12"	16	-	1,3	-	-	-
beak jolly 1,3x2 1/2"x3/4"	4	-	0,1	-	-	-

**BIO PLANK**

articolo	scatola			europallet		
	pz.	mq	kg	scat.	mq	kg
fondo 20x120 8"x48"	5	1,20	30,6	24	28,8	734,4
fondo deck 12x120 4 3/4"x48"	6	0,86	22,5	40	34,6	900,0
decoro fence 20x120 8"x48"	4	0,96	24,5	12	11,5	294,0
battiscopa 10x60 4"x24"	12	7,2 m.l.	18,0	55	396,0 m.l.	990,0
gradino plus 35x120 13 3/4"x48"	2	0,84	23,2	24	20,2	556,8
angolo gradino plus 35x120 13 3/4"x48"	1	0,42	12,4	24	10,1	297,6



**LEA CERAMICHE HA SCELTO MICROBAN®,  
IL LEADER MONDIALE NELLA PROTEZIONE ANTIBATTERICA**

*LEA CERAMICHE CHOOSES MICROBAN®,  
THE GLOBAL LEADER IN ANTIMICROBIAL TECHNOLOGY*

● **ATTIVA 24 ORE SU 24**  
*ACTIVE 24/7*

● **EFFICACE CONTRO I BATTERI**  
*EFFECTIVE AGAINST BACTERIA*

● **MOLTEPLICI APPLICAZIONI ED UTILIZZI**  
*MULTIPLE APPLICATIONS*

● **TRATTAMENTO PERMANENTE**  
*PERMANENT PROTECTION*

● **INTEGRATA NELLA PIASTRELLA**  
*INTEGRATED IN THE TILE*

● **EFFICACE SU OGNI SUPERFICIE**  
*EFFICIENT ON ANY SURFACE*



iso 14001



iso 9001



STABILIMENTO  
PANARIAGROUP  
TOANO (RE)



STABILIMENTO  
PANARIAGROUP  
FINALE E. (MO)



STABILIMENTO  
PANARIAGROUP  
FIORANO (MO)

emas

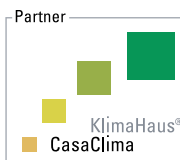

casaclima \*\*\*



leed\*

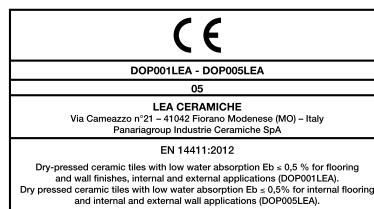

marchio CE



leed\*\*

\* LEED  
Lea Ceramiche, tramite la holding Panariagroup Industrie Ceramiche S.p.A., è socio ordinario del Green Building Council e del GBC Italia. Through Panariagroup Industrie Ceramiche S.p.A., Lea Ceramiche is an ordinary member of the Green Building Council and the GBC Italia. Par le biais de Panariagroup Industrie Ceramiche S.p.A., Lea Ceramiche est membre ordinaire du Green Building Council et du GBC Italia. Lea Ceramiche, durch die Holding Panariagroup Industrie Ceramiche S.p.A., ist ordentliches Mitglied von dem Green Building Council und dem GBC Italien. Lea Ceramiche, a través del holding Panariagroup Industrie Ceramiche S.p.A., es miembro afiliado del Consejo Construcción Verde y del Consejo Construcción Verde de Italia.

\*\* LEED  
Il contenuto di materiale riciclato "pre-consumo" delle serie Bio Lumber, Sunrise, Bio Timber, Bio Plank è del 40%, come certificato da ente esterno qualificato (certificato disponibile sul sito [www.ceramichelea.com](http://www.ceramichelea.com)). Bio Lumber, Sunrise, Bio Timber, Bio Plank are produced with 40% of pre-consumer materials, as certified by a qualified external company (certificate available on the website [www.ceramichelea.com](http://www.ceramichelea.com)).

\*\*\* CASACLIMA  
Lea Ceramiche, tramite la holding Panariagroup Industrie Ceramiche S.p.A., ha ottenuto la certificazione Partner Casaclima. Through Panariagroup Industrie Ceramiche S.p.A., Lea Ceramiche has obtained the Partner Casaclima certification. Par le biais de Panariagroup Industrie Ceramiche S.p.A., Lea Ceramiche a obtenu la certification Partner Casaclima. Lea Ceramiche, durch die Holding Panariagroup Industrie Ceramiche S.p.A., hat die Bescheinigung als Partner Casaclima bekommen. Lea Ceramiche, a través del holding Panariagroup Industrie Ceramiche S.p.A., ha obtenido la certificación Partner Casaclima.



ADIMEMBER



# Wood Experience



**LEA**  
CERAMICHE

LEA CERAMICHE  
Via Cameazzo, 21  
41042 Fiorano Modenese  
Modena Italy

Tel +39 0536 837811  
Fax +39 0536 830326  
info@ceramichelea.it  
www.ceramichelea.com

Panariagroup Industrie Ceramiche  
S.p.A.

SHOWROOM LEA CERAMICHE  
Via Durini, 3  
20122 Milano

Tel +39 02 76011406  
showroom\_milano@ceramichelea.it

LEA NORTH AMERICA, LLC  
800 Clanton Road, Suite N  
Charlotte, NC 28217

Tel +1 704 522 6300  
Fax +1 704 522 6080  
info@leausa.us  
www.leausa.us